



CITY

60360





Get excited about our new packaging!

We're switching from plastic to paper-based packaging. That's why you might find a mix of paper and plastic in our boxes!

Nos nouveaux emballages vous emballeront !

Nous passons des emballages en plastique aux emballages à base de papier. C'est pourquoi vous pourriez trouver un mélange de papier et de plastique dans nos boîtes !

¡Te presentamos nuestros nuevos empaques!

Estamos sustituyendo las bolsas de plástico por bolsas con base de papel. ¡Por eso, puedes encontrar una mezcla de papel y de plástico en nuestras cajas!

[LEGO.com/sustainable-packaging](https://www.lego.com/sustainable-packaging)



BUILDER



Apple and the Apple logo are trademarks of Apple Inc., registered in the U.S. and other countries and regions. App Store is a service mark of Apple Inc. Google Play and the Google Play logo are trademarks of Google LLC. Tencent and the Tencent logo are trademarks of Tencent Inc.

Q [LEGO.com/devicecheck](https://www.lego.com/devicecheck)

EN Ask parents' permission before going online | DE Eltern um Erlaubnis bitten, bevor du online gehst | FR Demande l'autorisation d'un parent avant d'aller en ligne | IT Chiedi il permesso ai tuoi genitori prima di andare online | ES Pídeles permiso a tus papás antes de conectarte a Internet | PT pede autorização aos pais antes de acederes online | JA オンラインになる前にほご者の方のきよかをもらおう | ZH 上网前应先征得父母的同意 | KO 온라인 접속 전에 보호자 동의가 필요합니다 | RU Спроси разрешения у родителей, прежде чем заходить в интернет | PL Poproś rodziców o zgodę, zanim wejdiesz do Internetu | CS Než půjdeš na internet, požádej rodiče o svolení | SK Skôr než pôjdeš na internet, vypýtaj si povolenie od rodičov | HU Kérj szülői engedélyt, mielőtt online csatlakoznál! | RO Cere permisiunea părinților înainte de a te conecta online | BG Поискайте разрешение от родител, преди да влезете онлайн | LV Pirms došanās tiešsaistē palūdz atļauju vecākiem | ET Enne Interneti kasutamist küsi vanematelt luba | LT Prieš prisijungdami prie interneto, atsiklauskite tėvų

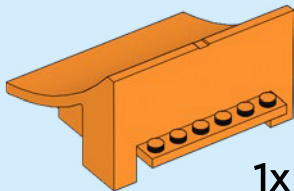
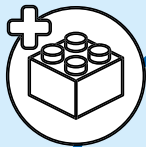

1x

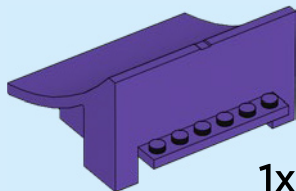

1x

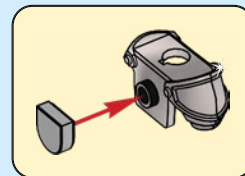

1

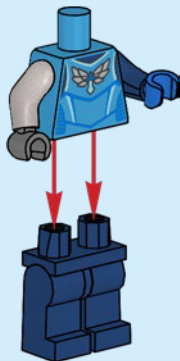

2

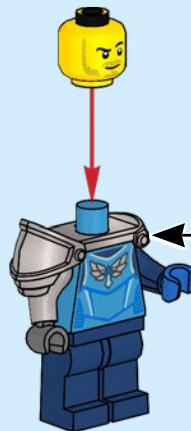

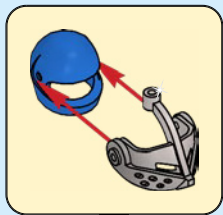
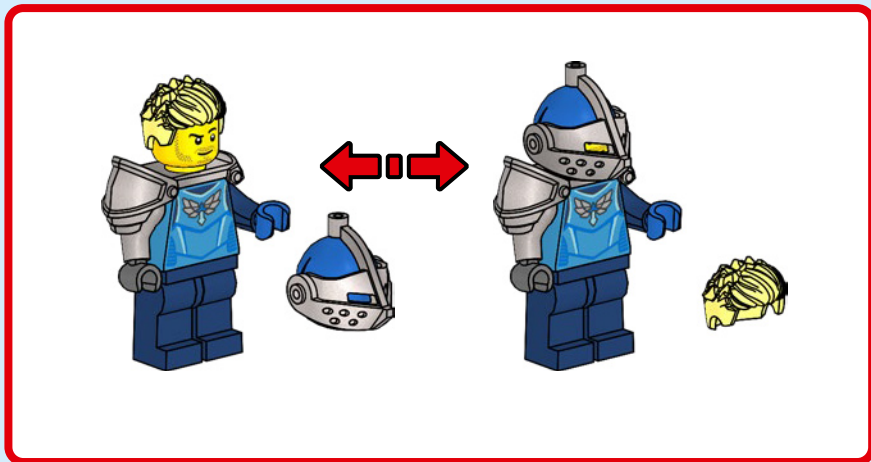

3

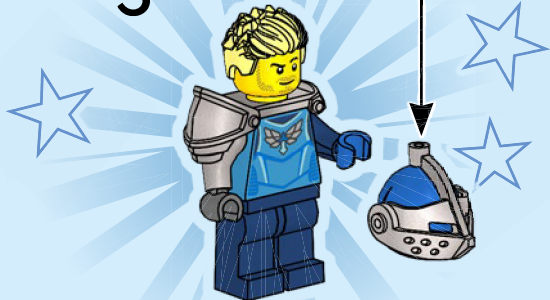

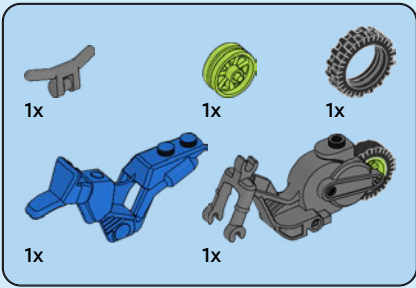

1

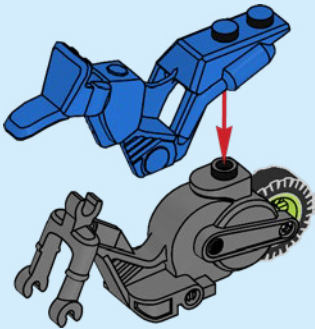

2

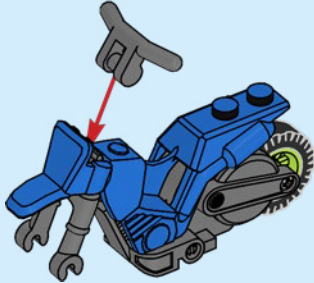

3

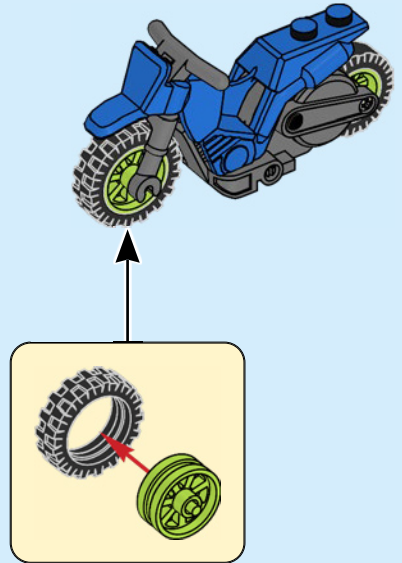

1

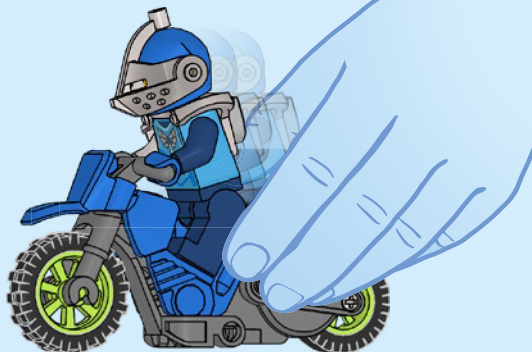

←... x3

2

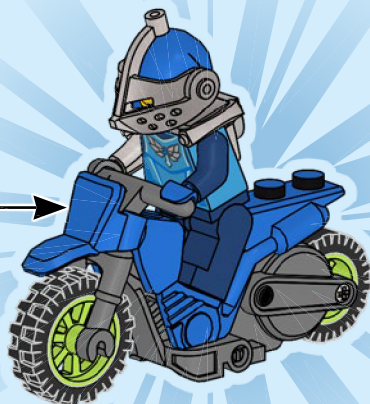
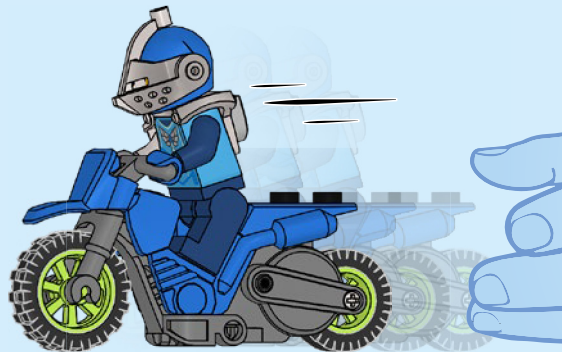

1



2

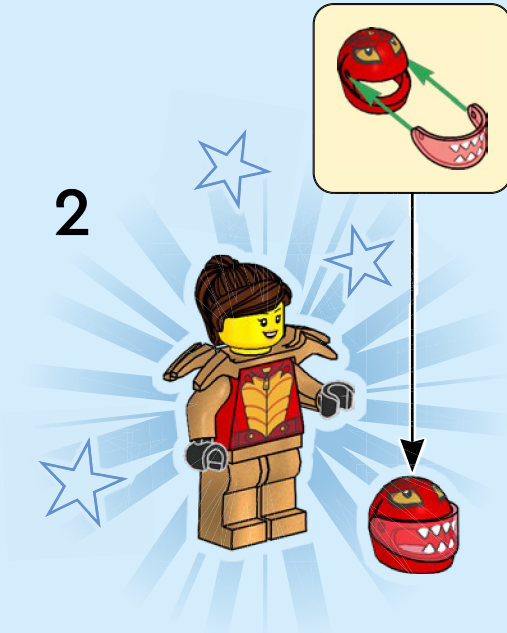

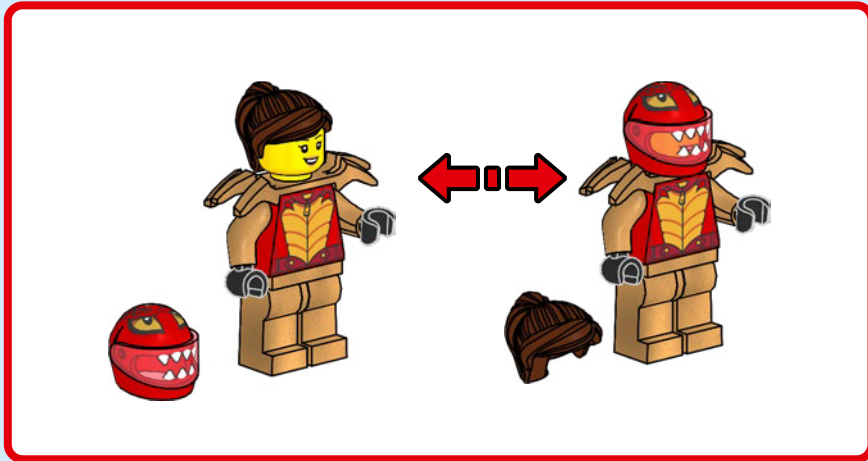

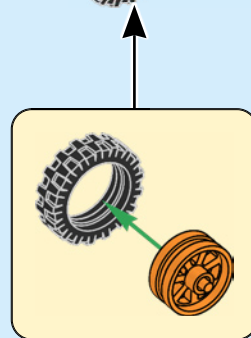
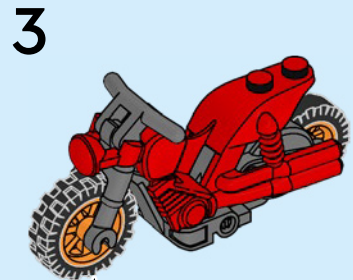
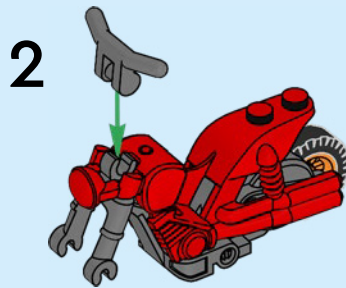
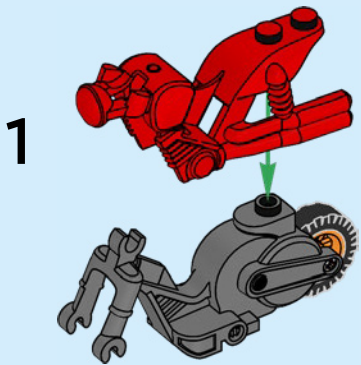
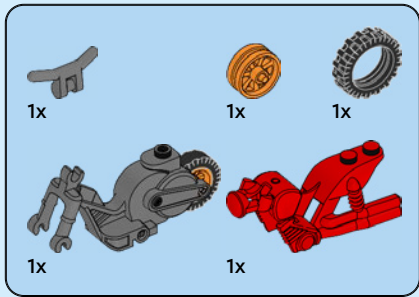

1

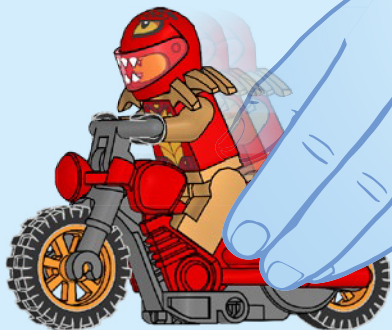

← ■■■ x3

2

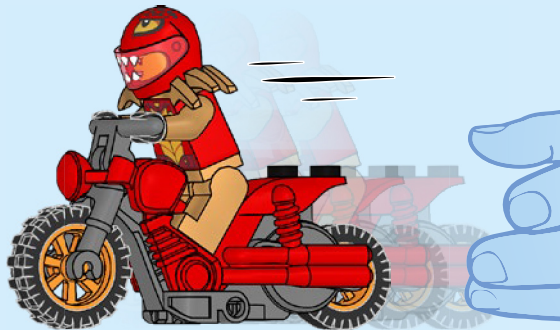

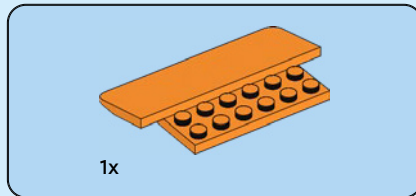
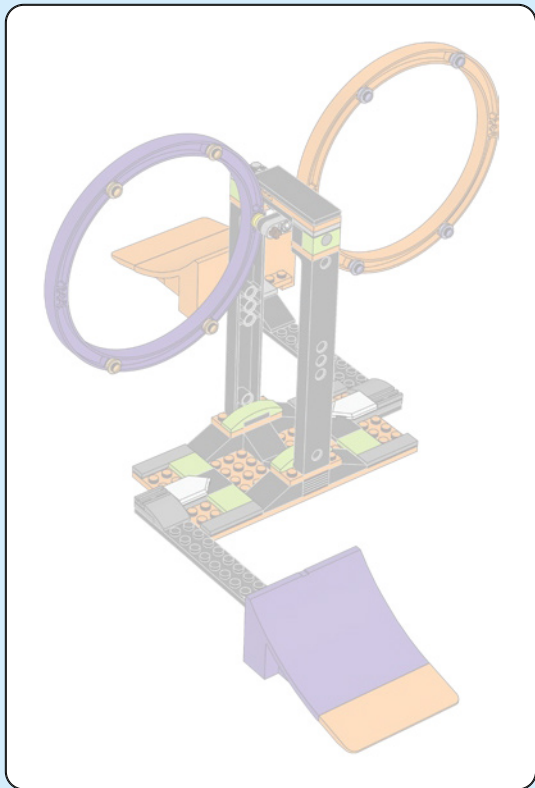

1x

1

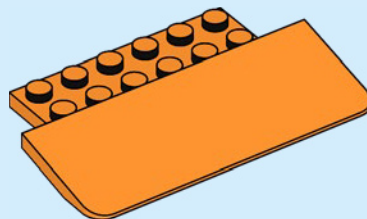

2

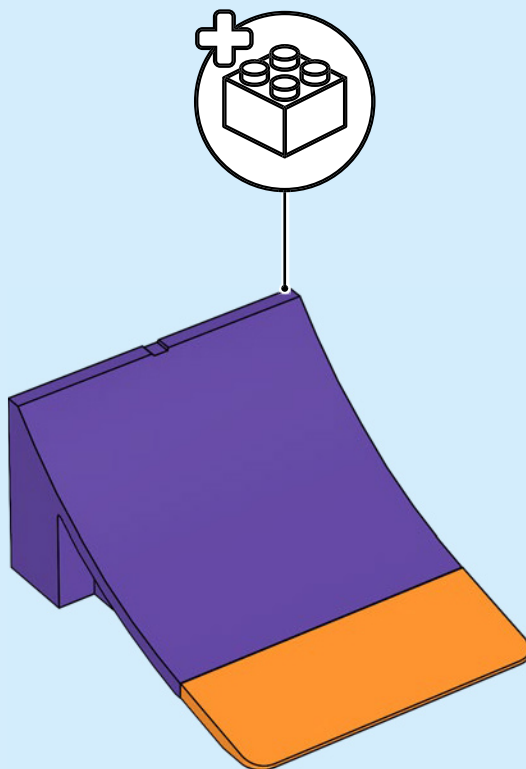

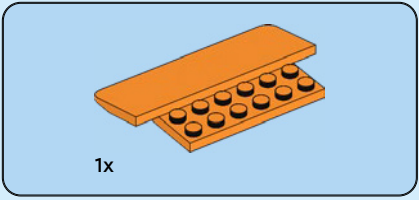

3

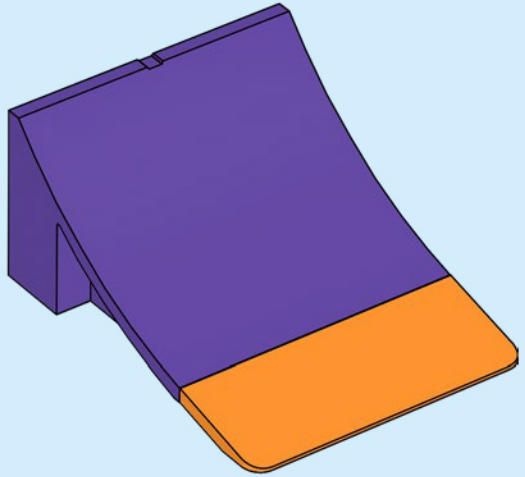
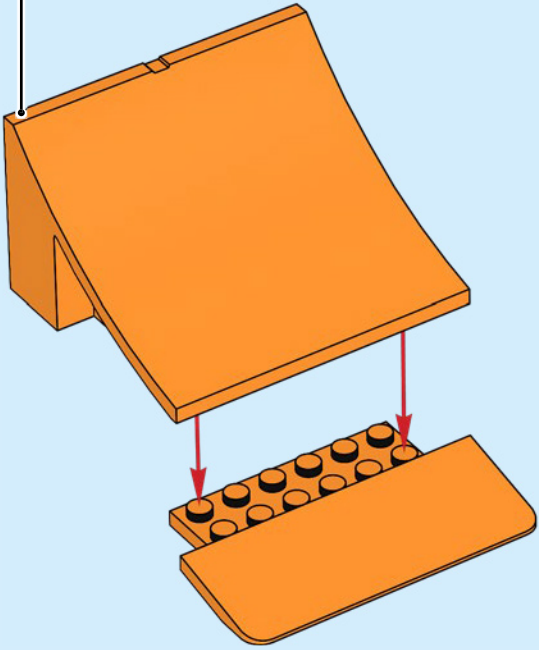
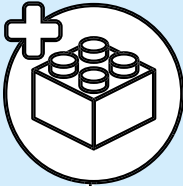

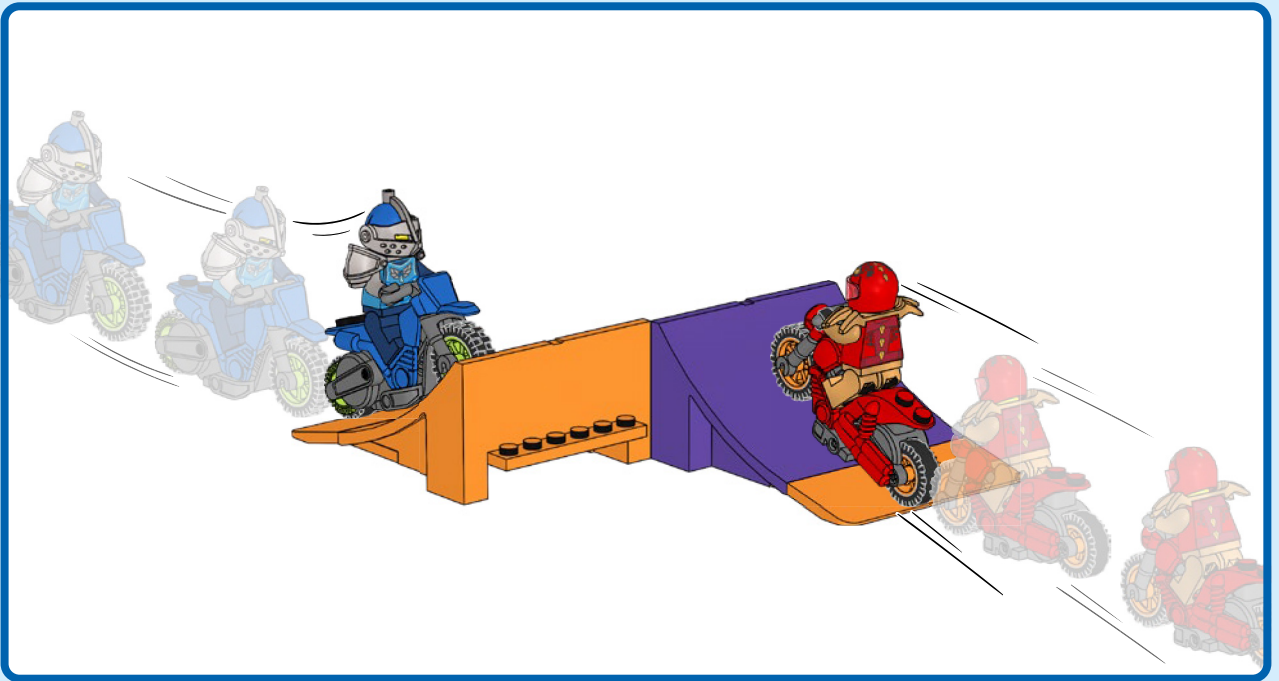

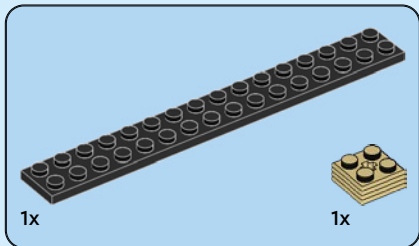
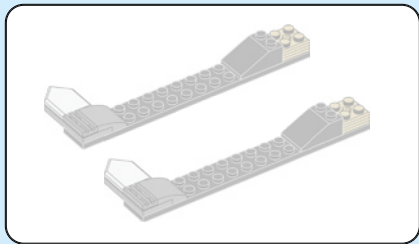

4

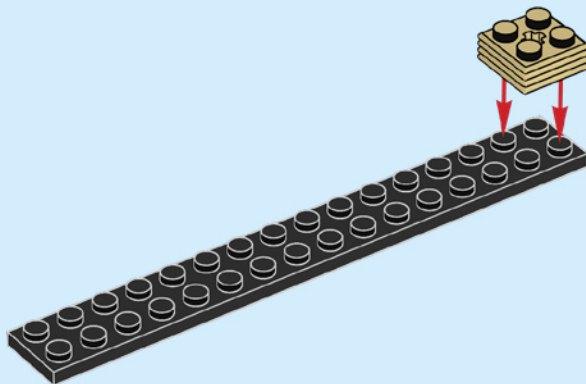

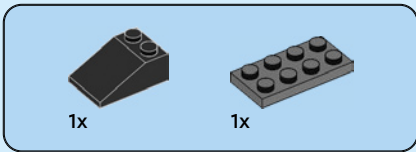

5

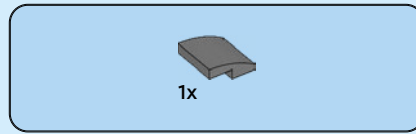
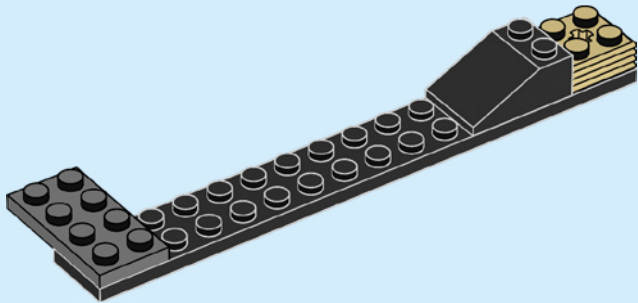

6

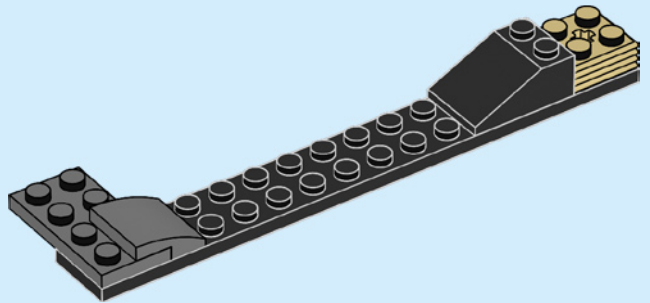



1x



1x

7

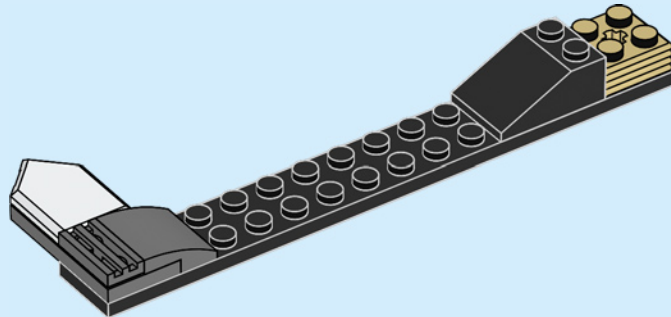

2x



8

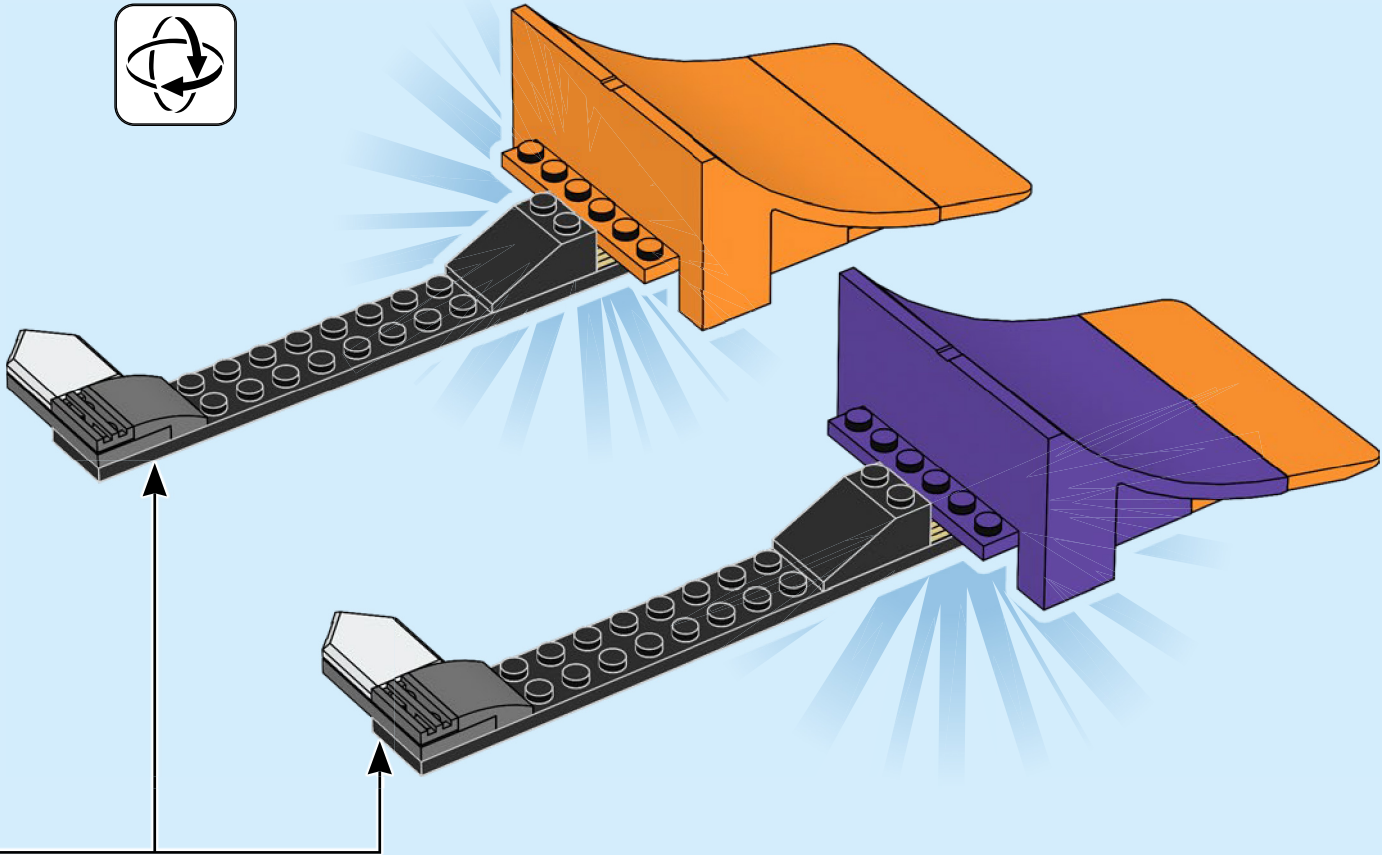



2x

9

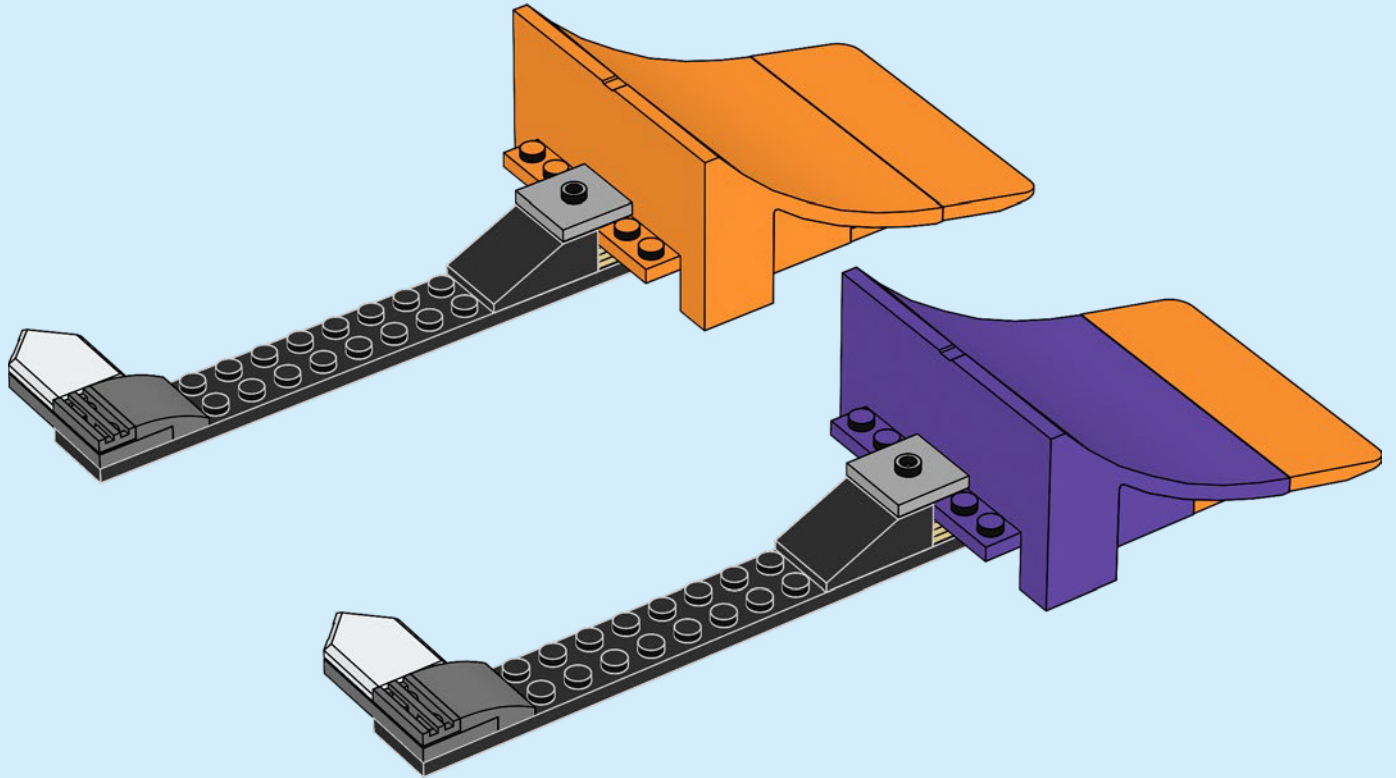

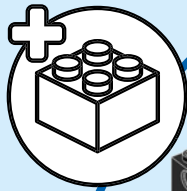

2x

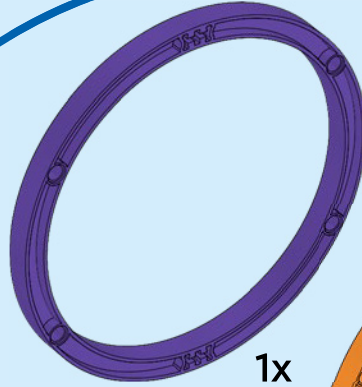

1x

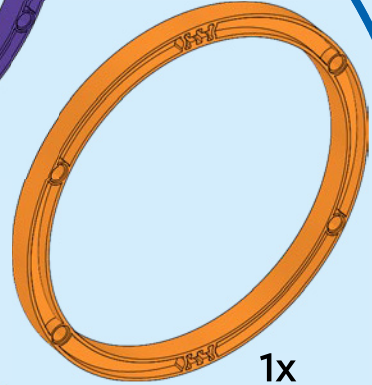

1x

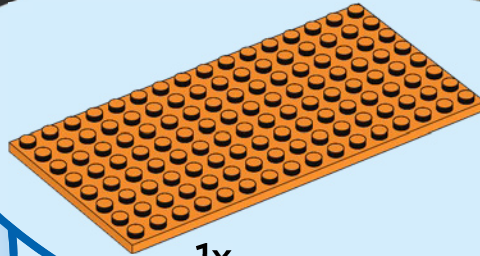

1x

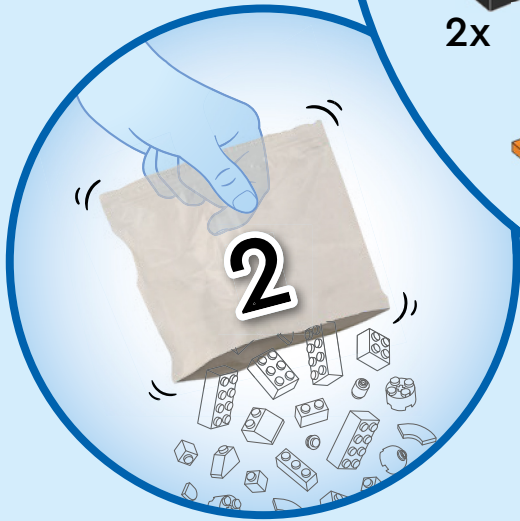

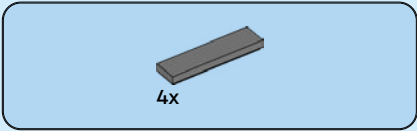

10

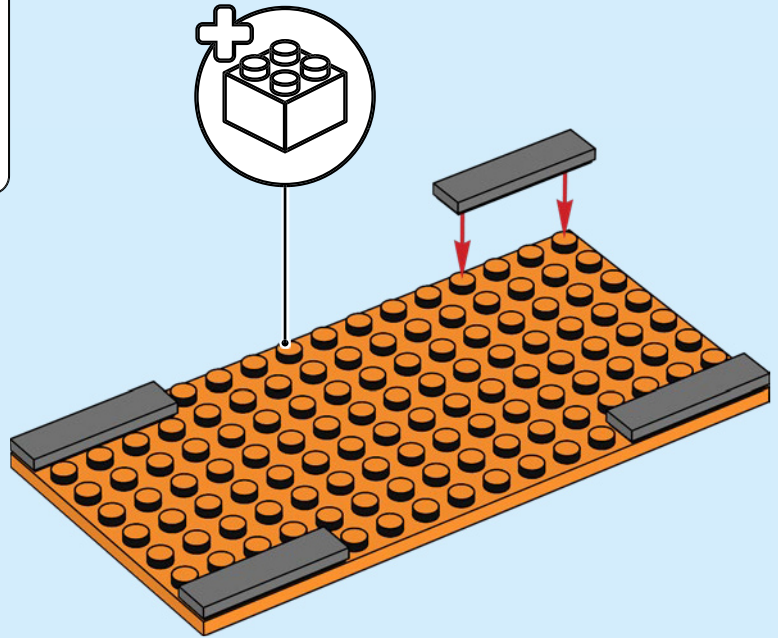

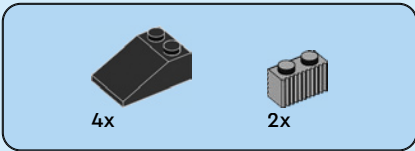

11

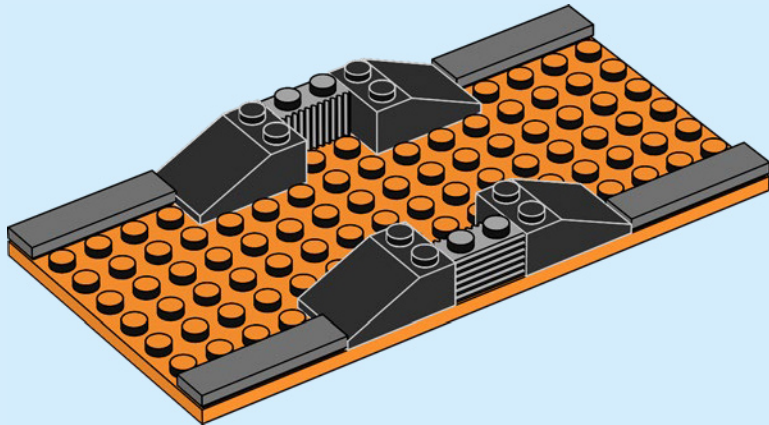



2x

12

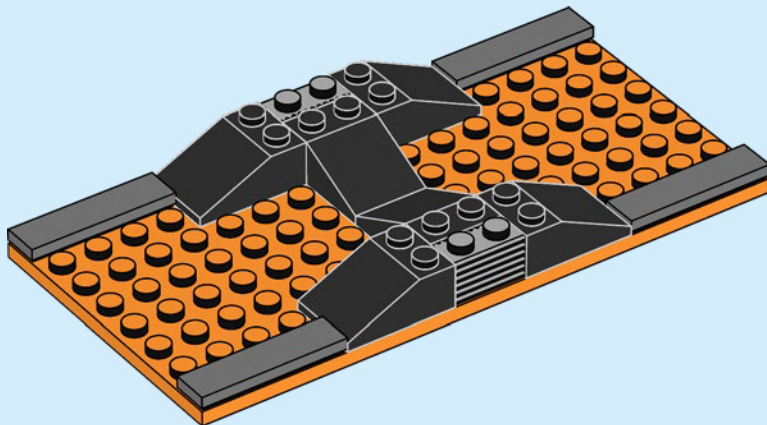

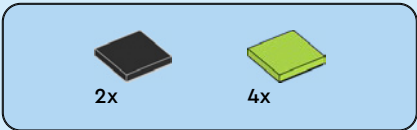

13

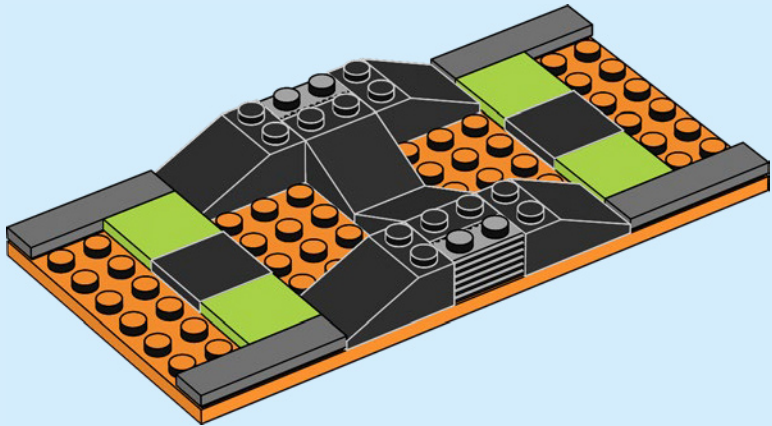

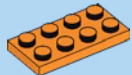

2x

14

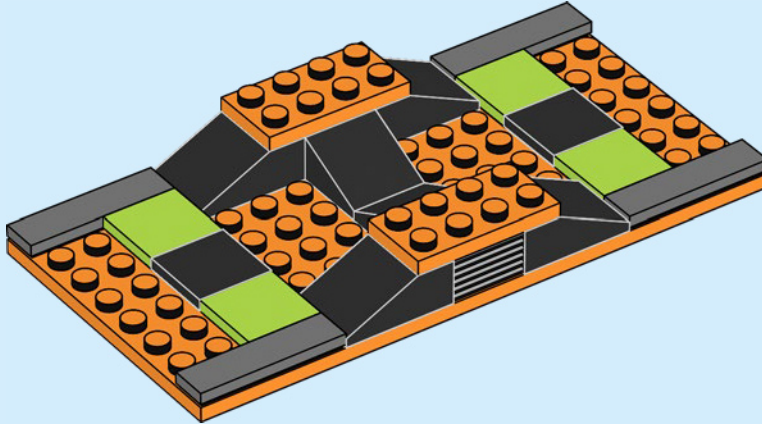

15

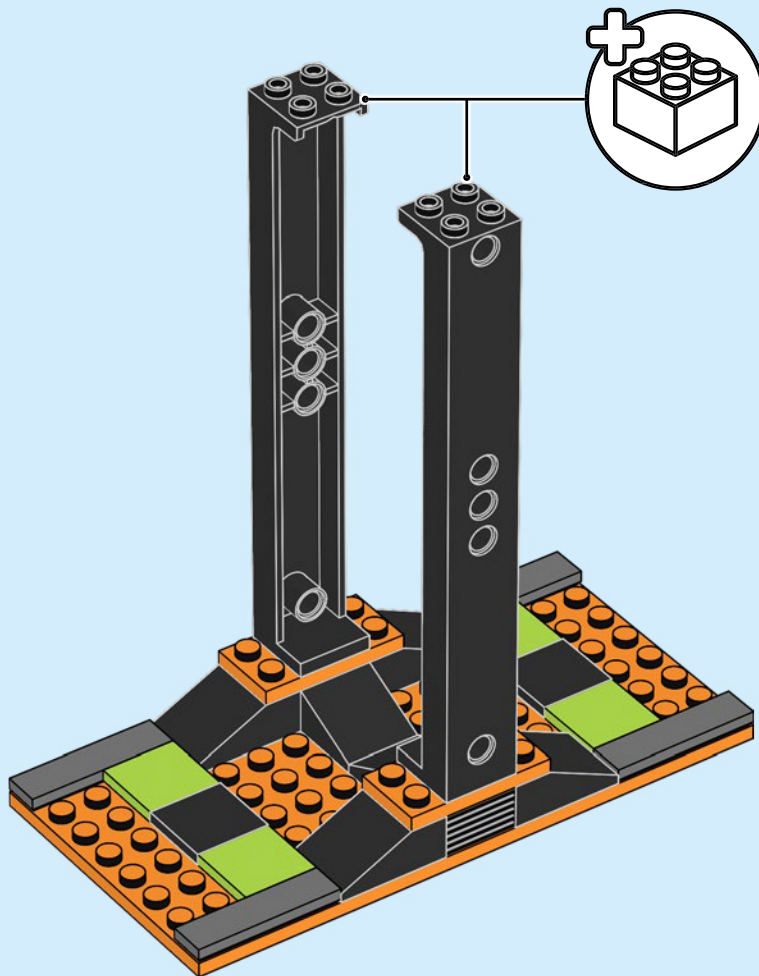

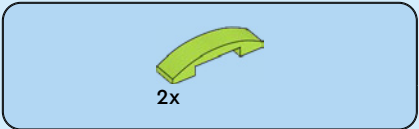

16

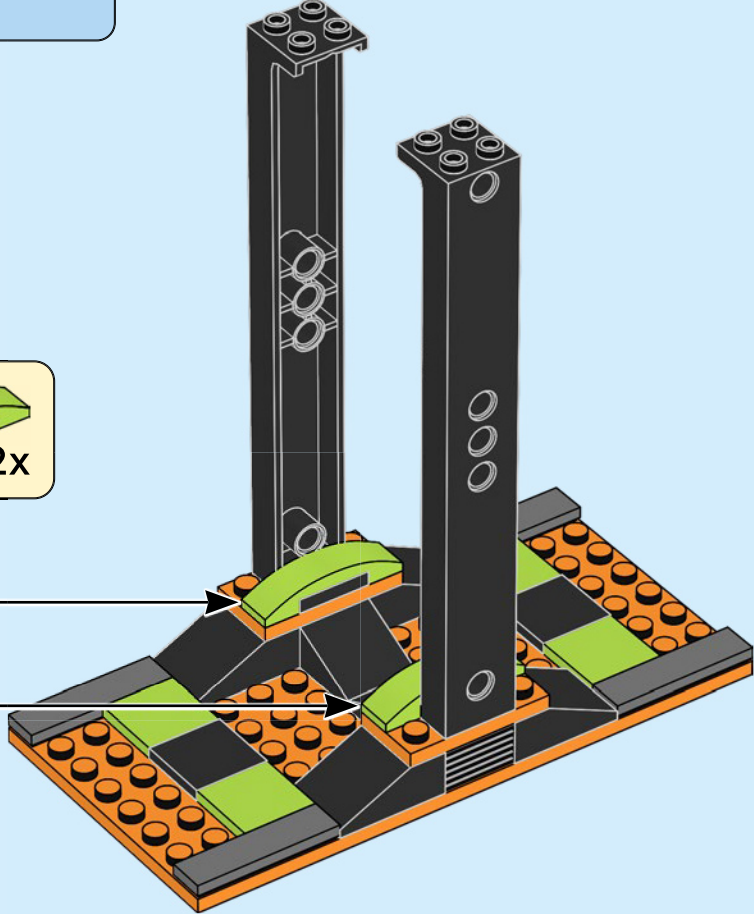
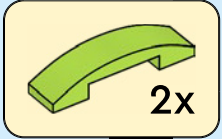

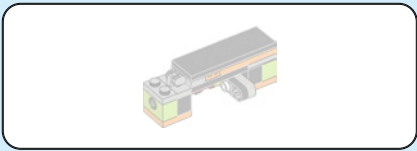

17

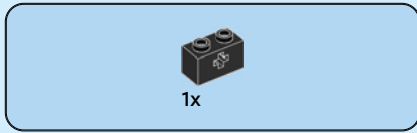
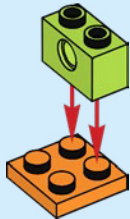

18



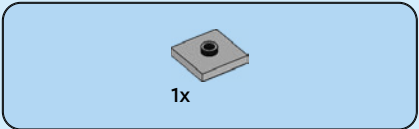

19

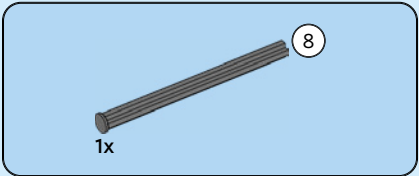

20

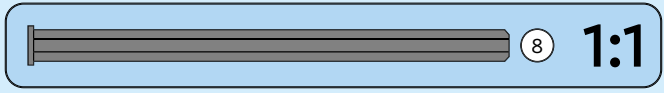
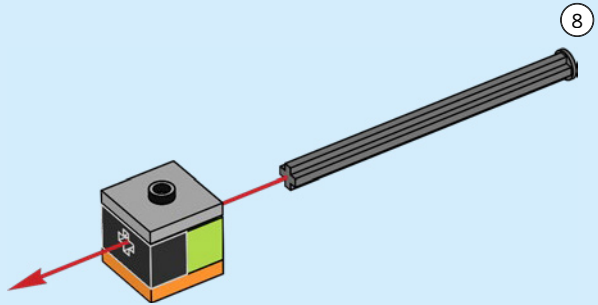

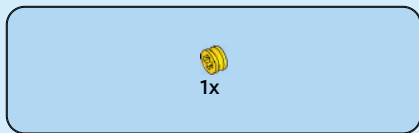

21

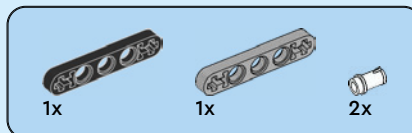
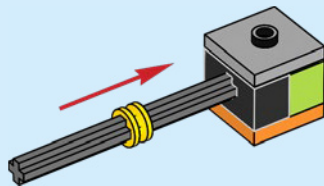

22

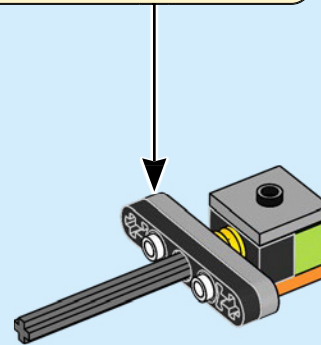
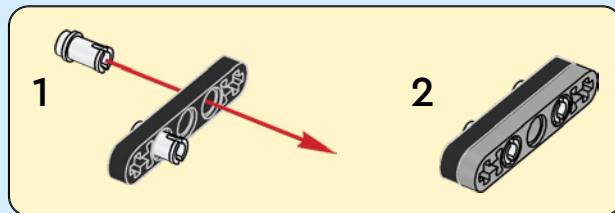



1x

23

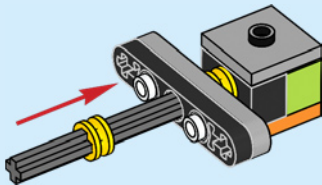

2x

24

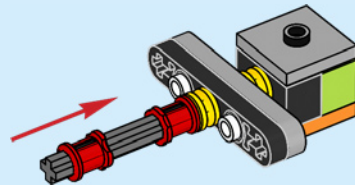

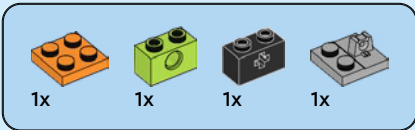

25

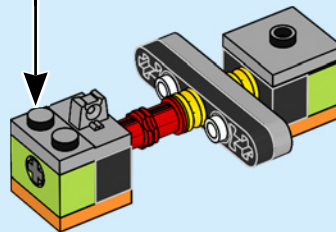
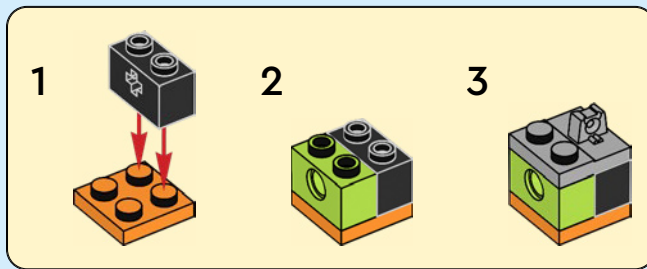

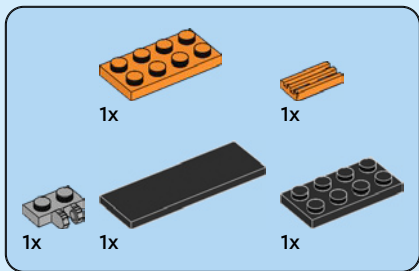

26

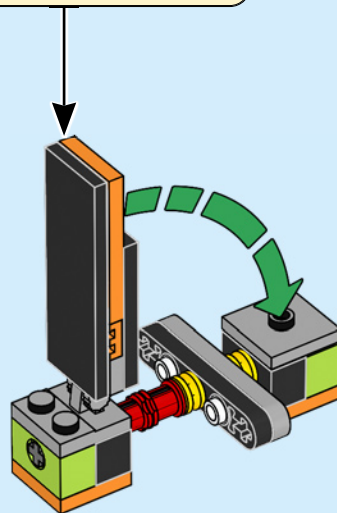
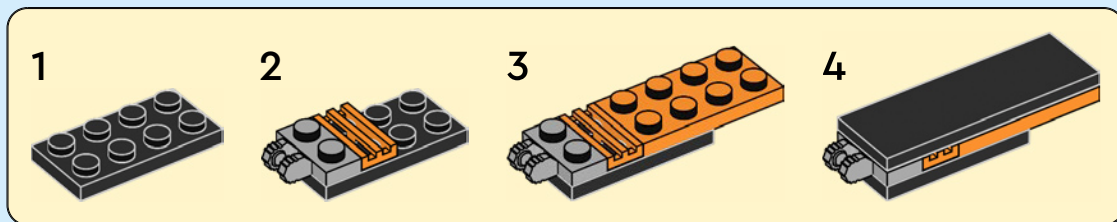

27

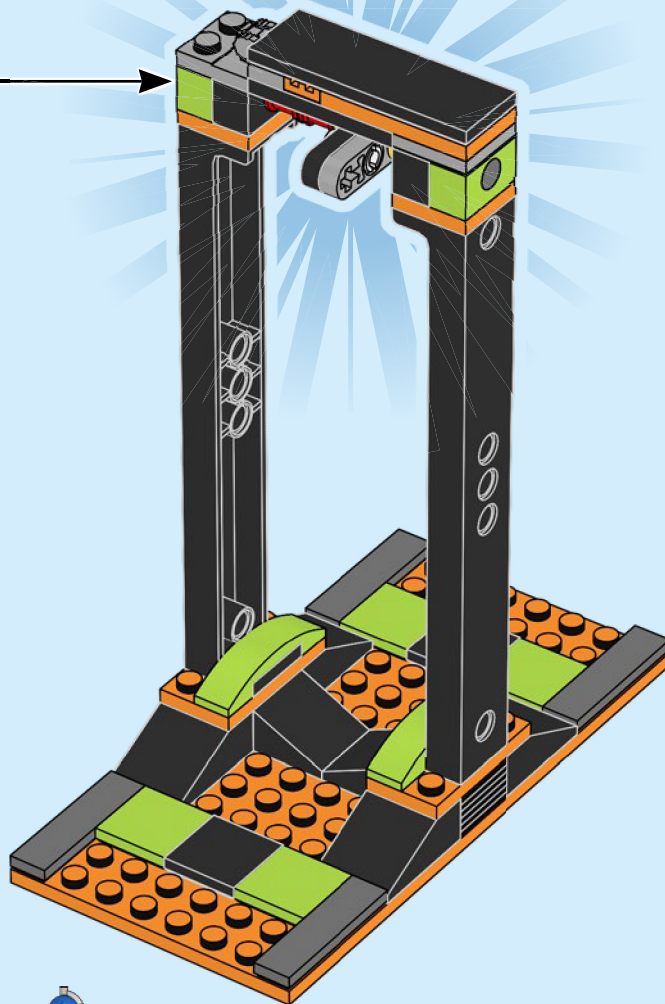

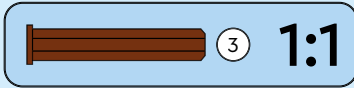
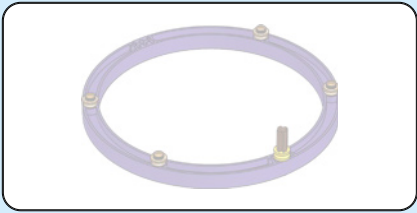

28

1

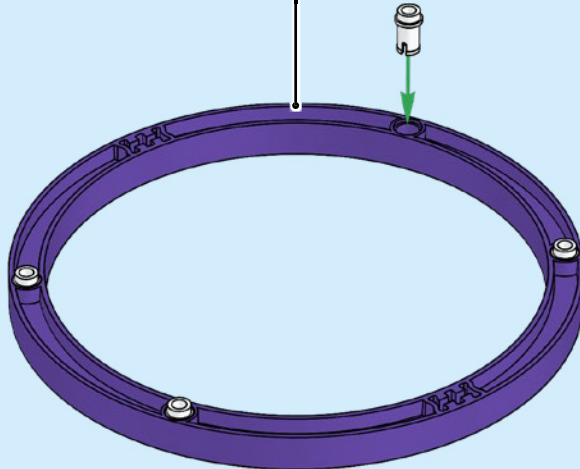
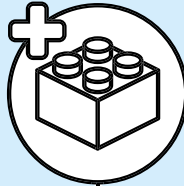

2

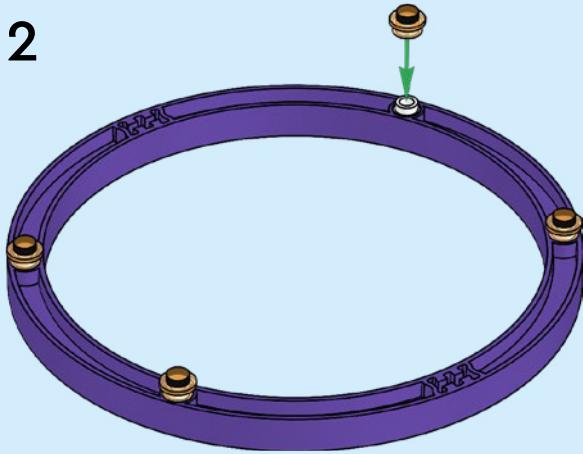

3

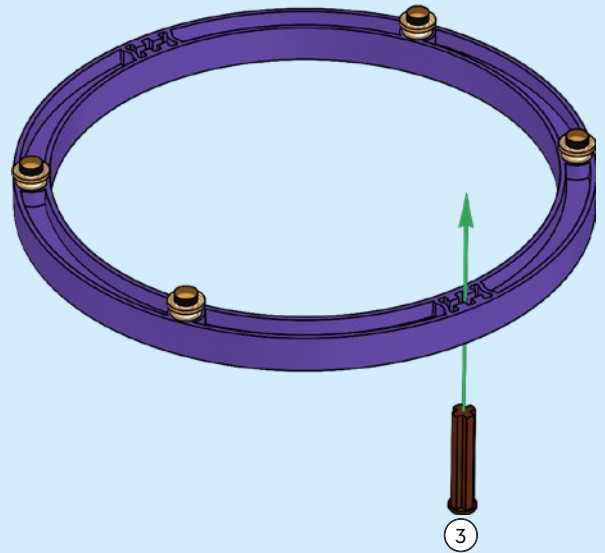

4

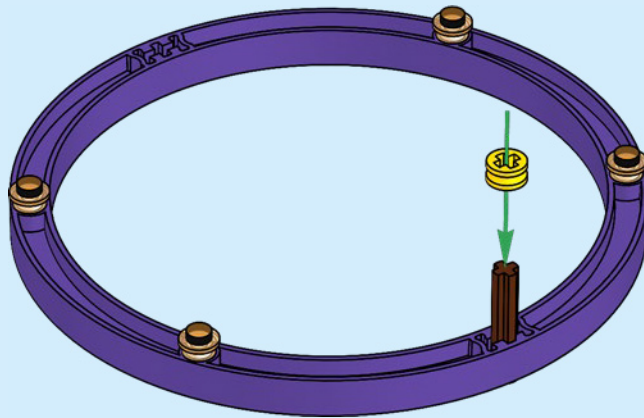

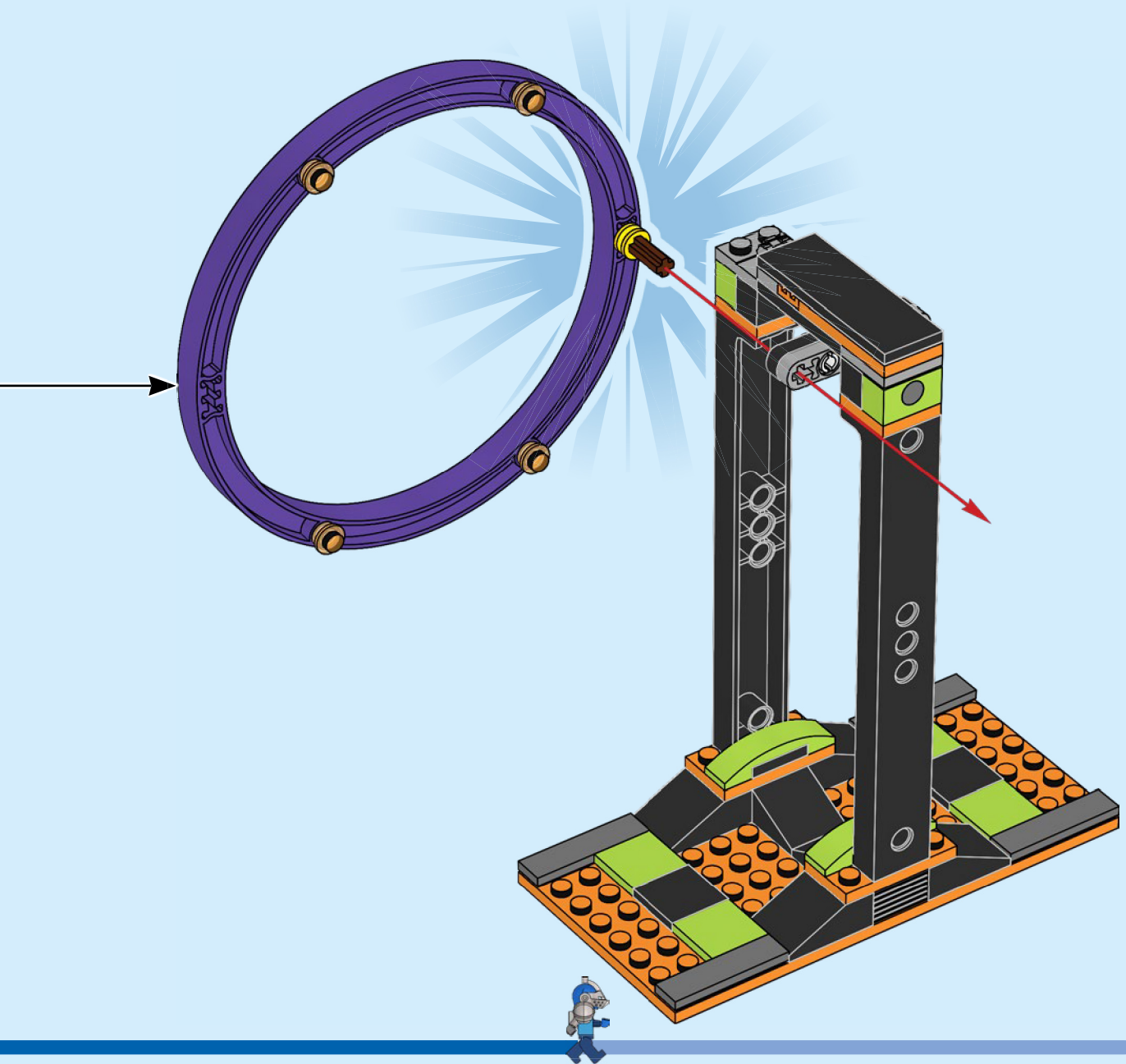

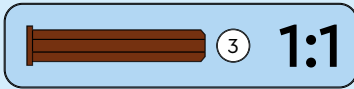
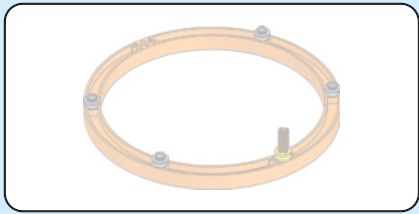

29

1

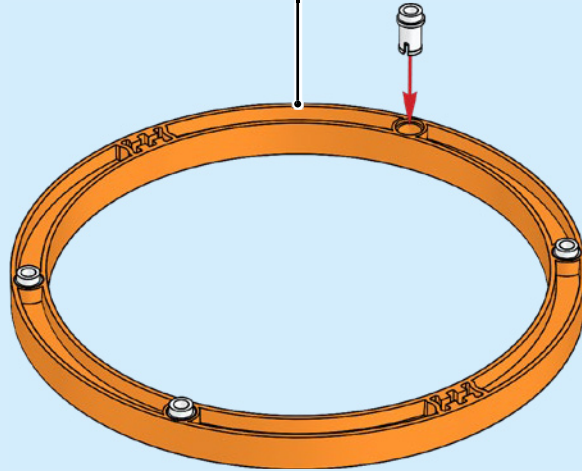
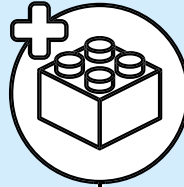

2

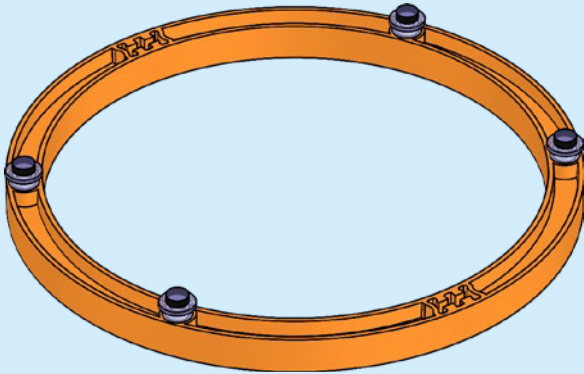

3

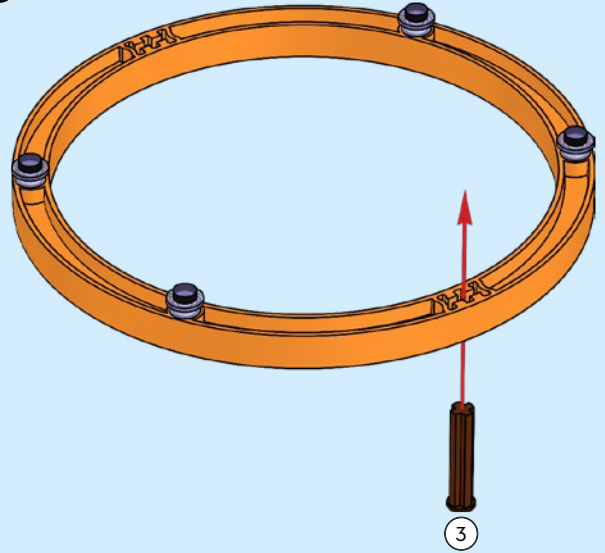

4

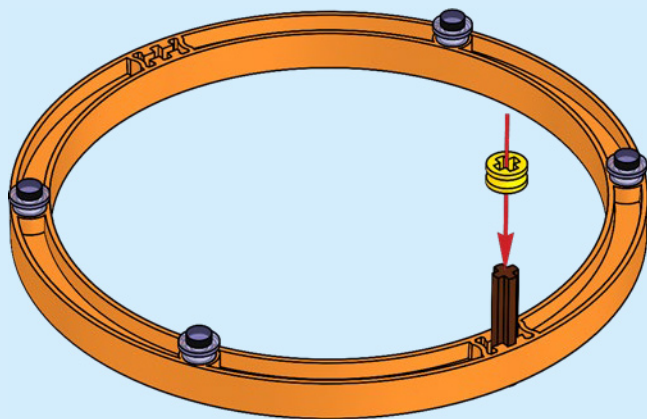



30

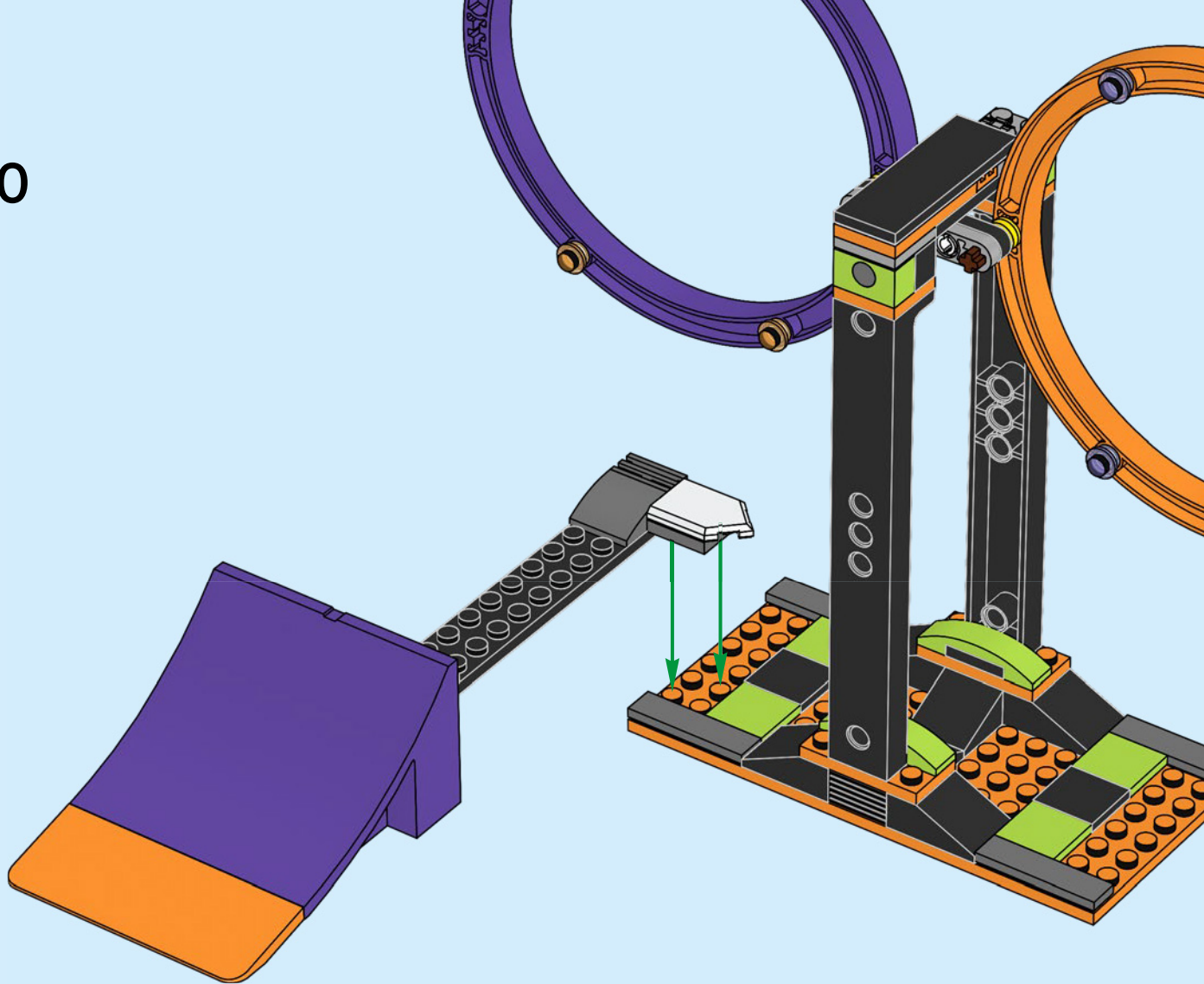

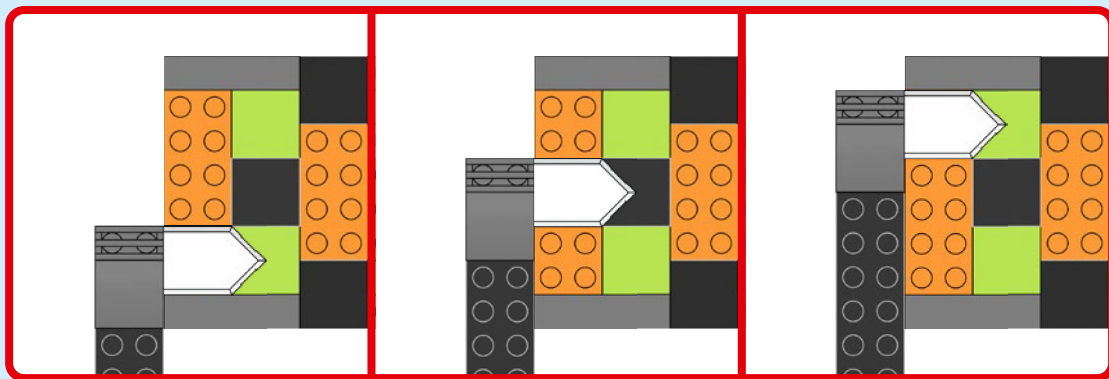
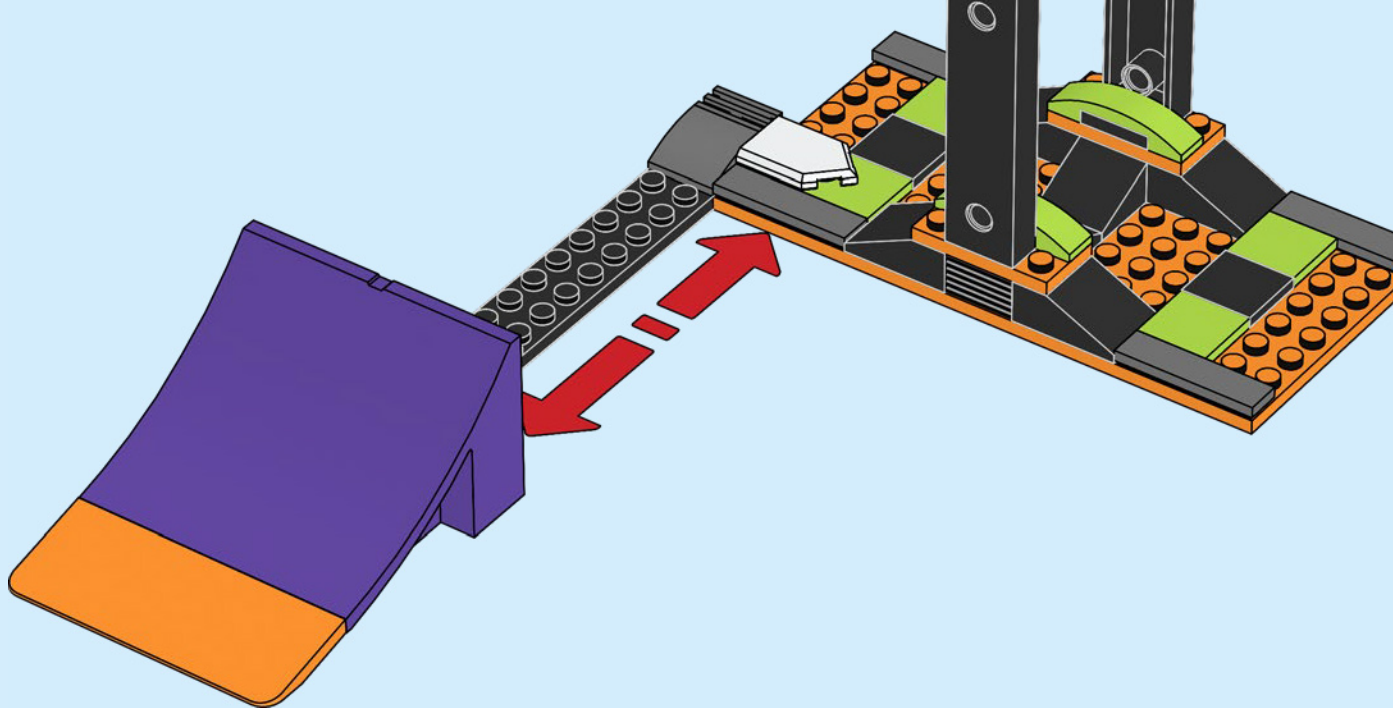

31





1

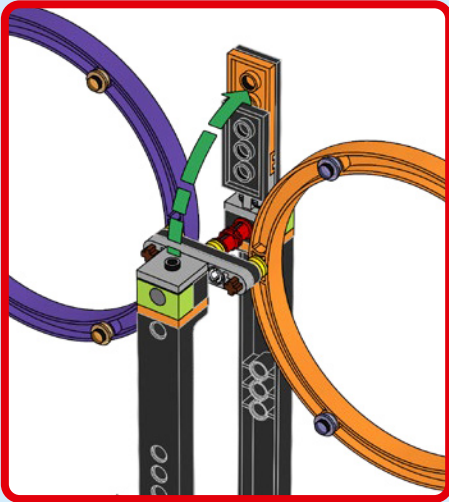

2

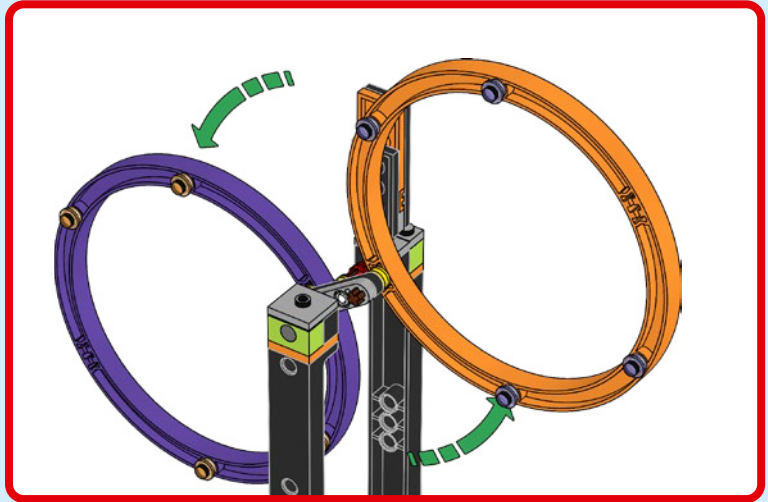

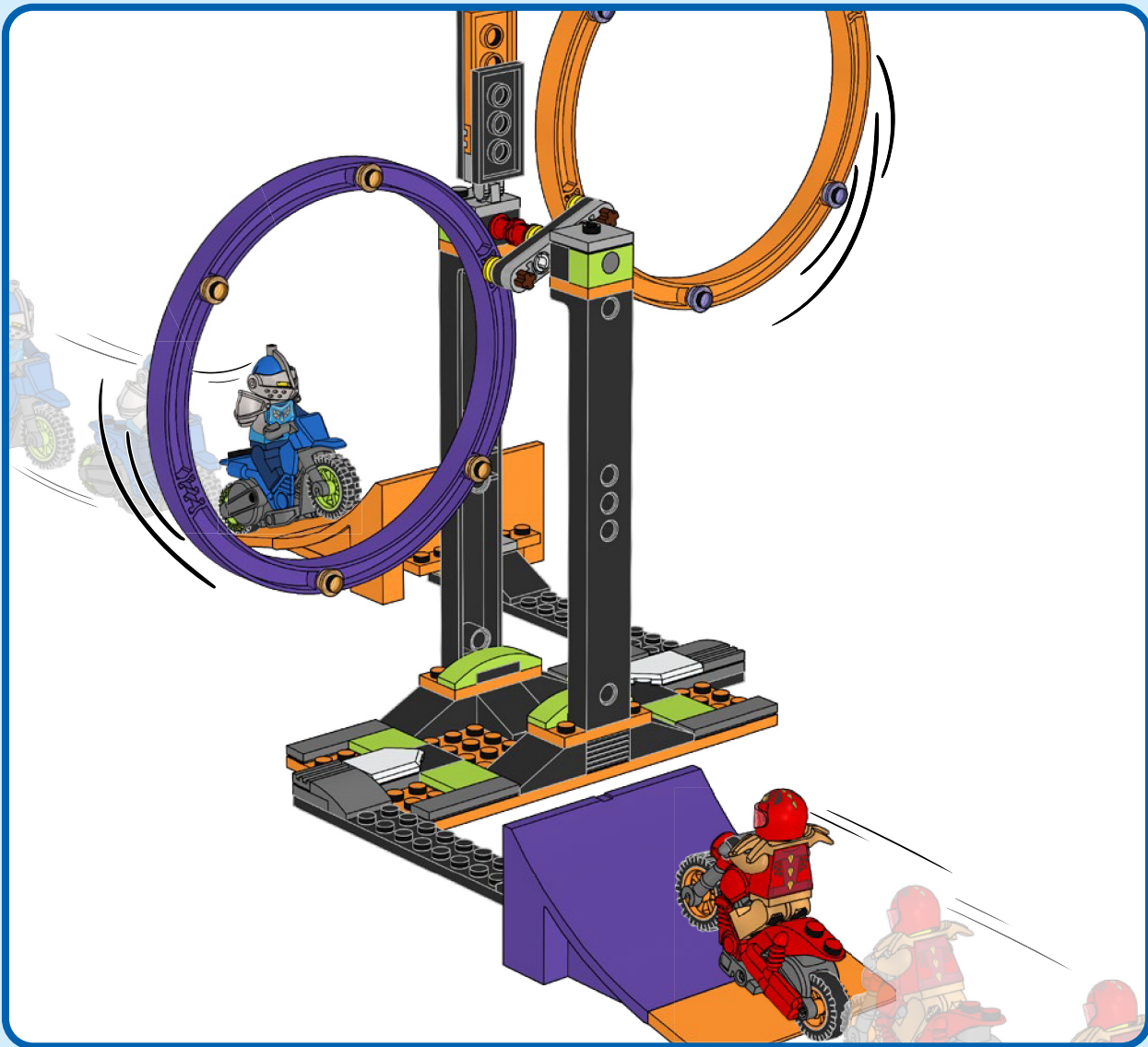



1x



1x



1x

1

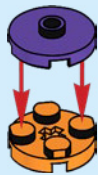

2





LEGO

CITY



STUNTZ



CITY



60387

60389

60383

60384

60385

10x
6388018

2x
6064174

1x
6411000

1x
4125254

2x
6245249

2x
306826

1x
6030521

2x
4159007

2x
6271820

2x
6438254

2x
6338339

3x
4158355

1x
6429712

1x
6353459

1x
6261501

1x
6437481

8x
329826

1x
6117636

1x
6437186

1x
6356480

1x
6327028

1x
4298618

1x
302026

1x
6438253

1x
6318582

1x
6434329

1x
6436435

2x
428226

2x
4210631

1x
6431181

4x
6271167

1x
6250597

1x
6409759

2x
4261908

2x
6132372

1x
6218310

2x
4211383

1x
6437405

2x
6071261

4x
4518611

1x
6270320

1x
6266209

2x
6330903

4x
4211053

2x
4617069

2x
6178922

3x
6126082

1x
4162916

2x
4211065

4x
6240210

1x
4512021

1x
6265742

1x
6429714

1x
4499858

4x
6240227

1x
6342520

1x
6328063

1x
6391388

1x
6093515

1x
6438632

1x
6403581

1x
6442057

2x
6135494

1x
6301362



 [LEGO.com/service](https://www.LEGO.com/service)

YOU COULD **WIN**



Scan this QR code or go to **LEGO.COM/PRODUCTFEEDBACK** and give us your short feedback about this LEGO® set for a chance to win a cool LEGO prize.

Terms and Conditions apply*

DE: Du könntest GEWINNEN. Es gelten die Teilnahmebedingungen* **FR: Tu pourrais GAGNER.** Des conditions s'appliquent* **IT: Potresti VINCERE tu.** Termini e condizioni sono applicabili* **ES: Puedes GANAR.** Aplican términos y condiciones* **PT: Poderá GANHAR.** Aplicam-se termos e condições* **JA: プレゼント付き! 利用規約が適用されます*** **ZH: 轻松获奖. 条款和条件适用*** **KO: 상품의 주인이 되어보세요. 소정의 약관이 적용됩니다*** **RU: Вы можете ВЫИГРАТЬ.** Действуют положения и условия* **PL: Szansa na WYGRANĄ.** Obowiązują warunki korzystania* **CS: Máte šanci VYHRÁT.** Platí všeobecné smluvní podmínky* **SK: Máte šancu VYHRAŤ.** Platia všeobecné zmluvné podmienky* **HU: TE IS NYERHETSZ.** Felhasználási feltételek érvényesek* **RO: Ai putea CÂȘTIGA.** Se aplică termeni și condiții* **BG: Можете да СПЕЧЕЛИТЕ.** Има определени правила и условия* **LV: Tu vari LAIMĒT.** Ir spēkā noteikumi un nosacījumi.* **ET: Sul on võimalus VÕITA.** Kehtivad tingimused* **LT: Jūs galite LAIMĖTI.** Taikomos sąlygos*
*LEGO.com/productfeedback-terms